

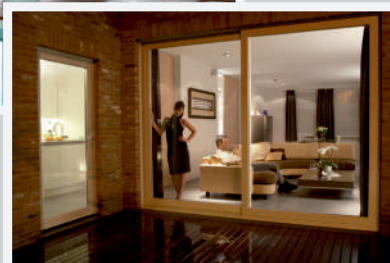

# LINEAR

Il massimo della praticità

**QID**<sup>®</sup>  
QUALITÀ INNOVAZIONE DESIGN

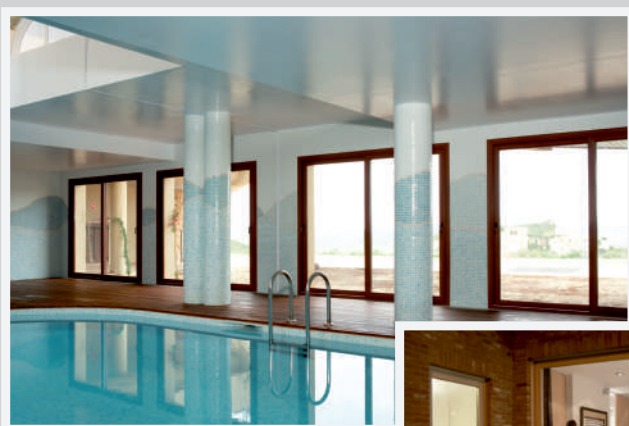

**LINEAR** è un sistema scorrevole che ha raggiunto un armonioso compromesso tra il classico ed il moderno, il cui design si basa su una leggera curvatura.

Il PVC è naturalmente isolante ed è il materiale ideale per ottenere i migliori risultati termici con lo scorrevole.

Le 3 camere di **LINEAR** consentono allo scorrevole, un eccellente coefficiente  $U_f=2,2/1,7 \text{ W/m}^2 \text{ K}$  in funzione della vetratura.



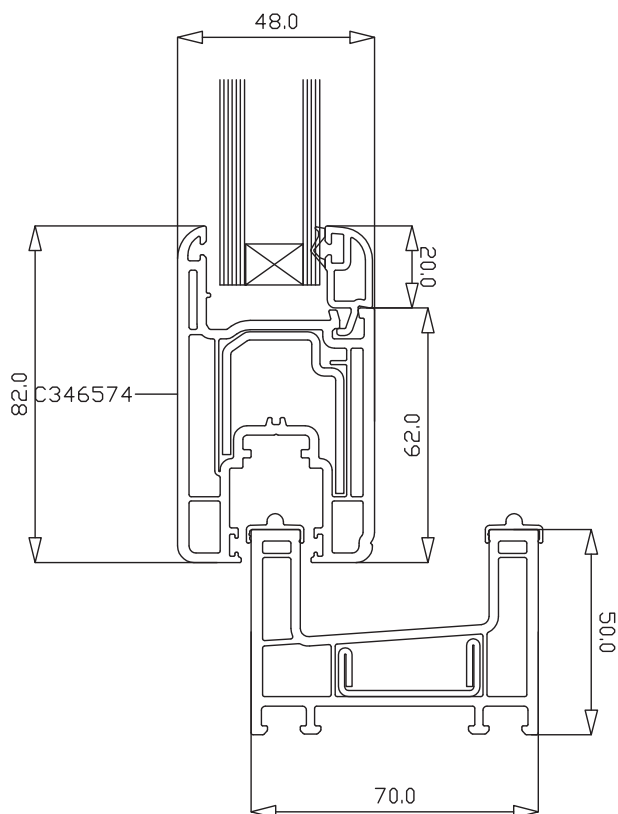
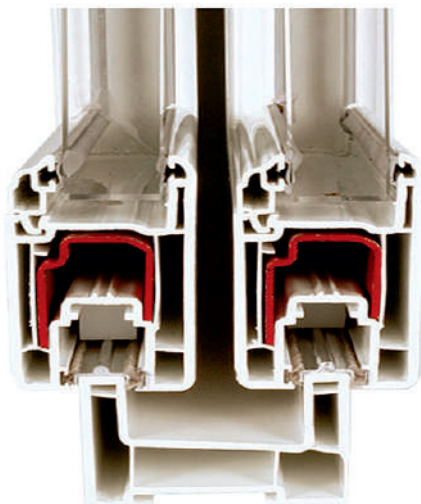

L'impiego di vetri da 5mm a 28mm di spessore, consente al sistema **LINEAR** di raggiungere le massime prestazioni in termini di isolamento.



## CARATTERISTICHE TECNICHE

Telaio	sezione da 70mm
Anta	sezione da 48mm
Sormonto anta-telaio	9mm
Aletta appoggio vetro	20mm
Vetratura	Spessore vetro da 5 mm a 30 mm

## PRESTAZIONI

ENERGIA		
	Isolamento termico	Uf=fino 1,7/2,2 W/m <sup>2</sup> K secondo vetri
	Classificazione	Clima S
COMFORT		
	Permeabilità all'aria - EN 12207	Classe 3
	Tenuta alla pioggia - EN 12208	Classe 5A
	Resistenza ai carichi del vento - EN 12210	Classe C4

**QID INFISSI S.R.L.**  
 Via Galileo Galilei, 22  
 80027 Frattamaggiore (NA)  
 Tel. +39 081 8805024  
 P. Iva 07237281212

www.qidinfissi.it

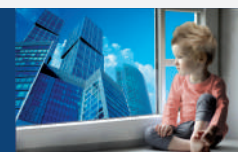

# LINEAR

**QID**  
 QUALITÀ INNOVAZIONE DESIGN

FINESTRE D'AUTORE